

**POWER  
HT +**

## User Guide

Gas fired floor-standing condensing boiler

POWER HT+ 1.50  
POWER HT+ 1.70  
POWER HT+ 1.90  
POWER HT+ 1.110

Dear customer,

Thank you for purchasing this appliance.

Please read this manual carefully before using the product and keep it in a safe place for future reference.

In order to ensure continued safe and efficient operation we recommend that the product is regularly maintained. Our Service and After Sales organization can assist with this.

We hope you will receive many years of satisfactory service.

# Contents

|          |  |           |
|----------|--|-----------|
| <b>1</b> | <b>Safety</b>  | <b>5</b>  |
| 1.1      | General safety instructions                                    | 5         |
| 1.2      | Recommendations  | 6         |
| 1.3      | Liabilities  | 7         |
| 1.3.1    | User's liability   | 7         |
| 1.3.2    | Installer's liability  | 8         |
| 1.3.3    | Manufacturer's liability                                       | 8         |
| <b>2</b> | <b>About this manual</b>                                       | <b>9</b>  |
| 2.1      | General  | 9         |
| 2.2      | Symbols used   | 9         |
| 2.2.1    | Symbols used in the manual                                     | 9         |
| 2.2.2    | Symbols used on the appliance                                  | 9         |
| <b>3</b> | <b>Technical specifications</b>                                | <b>10</b> |
| 3.1      | Homologations  | 10        |
| 3.1.1    | Ecodesign Directive  | 10        |
| 3.1.2    | Certifications   | 10        |
| 3.2      | Technical data   | 10        |
| 3.2.1    | Other technical parameters                                     | 11        |
| 3.2.2    | Sensor specifications  | 12        |
| <b>4</b> | <b>Description of the product</b>                              | <b>13</b> |
| 4.1      | General description  | 13        |
| 4.2      | Operating principle  | 13        |
| 4.2.1    | Circulation pump   | 13        |
| 4.2.2    | Gas/air setting  | 13        |
| 4.2.3    | Low-loss header (accessory)                                    | 13        |
| 4.2.4    | System in cascade  | 14        |
| 4.2.5    | Settings and safety devices                                    | 15        |
| 4.3      | Main components  | 16        |
| 4.4      | Control panel description                                      | 17        |
| 4.4.1    | Description of the keys  | 17        |
| 4.4.2    | Description of the symbols                                     | 17        |
| <b>5</b> | <b>Operation</b>   | <b>18</b> |
| 5.1      | Use of the control panel                                       | 18        |
| 5.1.1    | Modifying the user parameters                                  | 18        |
| 5.2      | Starting up the boiler   | 18        |
| 5.3      | Stopping the boiler  | 18        |
| 5.3.1    | Putting the boiler in Standby mode                             | 18        |
| 5.4      | Frost Protection   | 18        |
| 5.4.1    | Activating the <b>Off</b>                                      | 19        |
| <b>6</b> | <b>Settings</b>  | <b>20</b> |
| 6.1      | List of parameters   | 20        |
| 6.1.1    | Shortcuts menu   | 20        |
| 6.1.2    | Information menu   | 20        |
| 6.1.3    | List of user parameters  | 21        |
| 6.2      | Setting the parameters   | 23        |
| 6.2.1    | Setting the date and time                                      | 23        |
| 6.2.2    | Language Selection   | 24        |
| 6.2.3    | Setting a temporary heating flow temperature                   | 25        |
| 6.2.4    | Changing the operating mode                                    | 25        |
| 6.2.5    | Forcing domestic hot water production                          | 26        |
| 6.2.6    | Setting the room temperature set point ( <b>Onmode</b> )       | 26        |
| 6.2.7    | Modifying the domestic hot water production mode               | 27        |
| 6.2.8    | Setting the domestic hot water temperature set point           | 27        |
| 6.2.9    | Setting the room temperature set point ( <b>Reduced mode</b> ) | 28        |
| 6.2.10   | Programming a Holiday period                                   | 29        |
| 6.2.11   | Selecting a heating circuit                                    | 32        |
| 6.3      | Accessing the information menu                                 | 32        |

- 7 Maintenance . . . . . 33**
  - 7.1 General . . . . . 33
  
- 8 Troubleshooting . . . . . 34**
  - 8.1 Error codes . . . . . 34
    - 8.1.1 Automatic error code clearing . . . . . 34
    - 8.1.2 Clearing error codes . . . . . 34
  
- 9 Environmental . . . . . 35**
  - 9.1 Energy savings . . . . . 35
  - 9.2 Room thermostat and settings . . . . . 35
  
- 10 Disposal . . . . . 36**
  - 10.1 Disposal and Recycling . . . . . 36
  
- 11 Warranty . . . . . 37**
  - 11.1 General . . . . . 37
  - 11.2 Terms of warranty . . . . . 37
  
- 12 Appendix . . . . . 38**
  - 12.1 Product fiche - Boiler space heaters . . . . . 38
  - 12.2 Product fiche - Temperature Controls . . . . . 38
  - 12.3 Package fiche . . . . . 39

# 1 Safety

## 1.1 General safety instructions

**Danger**

This appliance can be used by children aged from 8 years and above and persons with reduced physical, sensory or mental capabilities or lack of experience and knowledge if they have been given supervision or instruction concerning use of the appliance in a safe way and understand the hazards involved. Children shall not play with the appliance. Cleaning and user maintenance shall not be made by children without supervision.

**Danger**

If you smell gas:

1. Do not use a naked flame, do not smoke, do not operate electrical contacts or switches (doorbell, light, motor, lift, etc.).
2. Shut off the gas supply.
3. Open the windows.
4. Trace possible leaks and seal them immediately.
5. If the gas leak is before the gas meter, contact the gas supplier.

**Danger**

If you smell flue gases:

1. Switch off the appliance.
2. Open the windows.
3. Trace possible leaks and seal them immediately.

**Warning**

Do not touch the flue gas pipes. Depending on the boiler settings, the temperature of the flue gas pipes may exceed 60°C.

**Warning**

Do not touch the radiators for long periods. Depending on the boiler settings, the temperature of the radiators may exceed 60°C.

**Warning**

Take precautions with the domestic hot water. Depending on the boiler settings, the domestic hot water temperature may exceed 65°C.

**Danger of electric shock**

Before any work, switch off the mains supply to the boiler.

## 1.2 Recommendations

---



**Note**

Keep this document close to the place where the appliance is installed.



**Note**

Never remove or cover labels and data plates affixed to the appliances. Labels and data plates must be legible throughout the entire lifetime of the appliance. Immediately replace damaged or illegible instructions and warning stickers.



**Caution**

The appliance should be on Summer or Antifreeze mode rather than switched off to guarantee the following functions:

- Anti-blocking of pumps
- Frost Protection



**Caution**

If the home is unoccupied for a long period and there is a risk of frost, drain the boiler and the heating system.



**Caution**

To enjoy warranty cover, no modifications must be made to the appliance.



**Caution**

The frost protection does not work if the boiler is switched off.



**Caution**

The integrated protection system only protects the boiler, not the heating installation



**Caution**

Remove the boiler casing only to perform maintenance and repair work. Always put the casing back in place after such work.



**Warning**

Only qualified professionals are authorised to work on the boiler and the heating installation.



**Note**

Keep the boiler accessible at all times.



**Caution**

Installation of the boiler must be done by a qualified professional in accordance with prevailing local and national regulations.





**Caution**

Install the boiler in a frost-free location.

 **Caution**  
Do not stock chloride or fluoride compounds close to the boiler. They are particularly corrosive and may contaminate the combustive air. Chloride and fluoride compounds are present in aerosol sprays, paints, solvents, cleaning products, washing products, detergents, glues, snow clearing salts.

 **Caution**  
Do not neglect to service the boiler. Contact a qualified professional or subscribe to a maintenance contract for the annual servicing of the boiler.

 **Note**  
Regularly check the presence of water and pressure in the heating installation.

 **Caution**  
Maintenance work must be carried out by a qualified professional.

 **Caution**  
Only a qualified professional is authorised to clean the inside of the boiler.

 **Caution**  
Only genuine spare parts may be used.

 **Caution**  
After maintenance or repair work, check the entire heating installation to ensure that there are no leaks.

 **Warning**

- Ensure correct earthing.
- Install the appliance on a solid, stable structure able to bear its weight.

 **Warning**  
Removal and disposal of the boiler must be carried out by a qualified installer in accordance with local and national regulations

 **Caution**  
If the power cord is damaged, it must be replaced by the manufacturer, its after sales service or persons with similar qualifications in order to obviate any danger.

## 1.3 Liabilities

### 1.3.1 User's liability

To guarantee optimum operation of the system, you must abide by the following instructions:

- Read and follow the instructions given in the manuals provided with the appliance.

- Call on a qualified professional to carry out installation and initial commissioning.
- Get your installer to explain your installation to you.
- Have the required inspections and maintenance carried out by a qualified installer.
- Keep the instruction manuals in good condition close to the appliance.

### 1.3.2 Installer's liability

---

The installer is responsible for the installation and initial commissioning of the appliance. The installer must abide by the following instructions:

- Read and follow the instructions given in the manuals provided with the appliance.
- Install the appliance in compliance with prevailing legislation and standards.
- Carry out initial commissioning and any checks necessary.
- Explain the installation to the user.
- If maintenance is necessary, warn the user of the obligation to check the appliance and keep it in good working order.
- Give all the instruction manuals to the user.

### 1.3.3 Manufacturer's liability

---

Our products are manufactured in compliance with the requirements of the various Directives applicable. They are therefore delivered with the  $\zeta$  marking and any documents necessary. In the interests of the quality of our products, we strive constantly to improve them. We therefore reserve the right to modify the specifications given in this document.

Our liability as manufacturer may not be invoked in the following cases:

- Failure to abide by the instructions on installing the appliance.
- Failure to abide by the instructions on using the appliance.
- Faulty or insufficient maintenance of the appliance.



## 2 About this manual

### 2.1 General

This manual is intended for the user of a POWER HT + heat pump. This manual can also be found on our internet site.

### 2.2 Symbols used

#### 2.2.1 Symbols used in the manual

This manual uses various danger levels to draw attention to special instructions. We do this to improve user safety, to prevent problems and to guarantee correct operation of the appliance.



#### Danger

Risk of dangerous situations that may result in serious personal injury.



#### Danger of electric shock

Risk of electric shock.



#### Warning

Risk of dangerous situations that may result in minor personal injury.



#### Caution

Risk of material damage.



#### Note

Please note: important information.



#### See

Reference to other manuals or pages in this manual.

#### 2.2.2 Symbols used on the appliance

Fig.1 Symbols used on the appliance

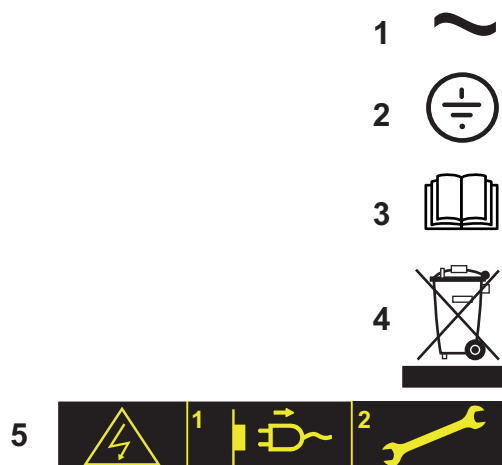

MW-2000068-1

- 1 Alternating current.
- 2 Protective earthing.
- 3 Before installing and commissioning the appliance, carefully read the instruction manuals provided.
- 4 Dispose of used products through an appropriate recovery and recycling structure.
- 5 Caution: danger of electric shock, live parts. Disconnect the mains power prior to carrying out any work.

## 3 Technical specifications

### 3.1 Homologations

#### 3.1.1 Ecodesign Directive

This product conforms to the requirements of European Directive 2009/125/EC on the ecodesign of energy-related products.

#### 3.1.2 Certifications

We hereby certify that the series of appliances specified below complies with the standard model described in the CE declaration of conformity.

|                             |  |
|-----------------------------|--|
| CE number                   | CE-0085CP0089  |
| NOx class                   | Class 5  |
| Type of flue gas connection | <ul style="list-style-type: none"> <li>• B<sub>23</sub> – B<sub>23P</sub></li> <li>• C<sub>13</sub></li> <li>• C<sub>33</sub></li> <li>• C<sub>43</sub></li> <li>• C<sub>53</sub></li> <li>• C<sub>63</sub></li> <li>• C<sub>83</sub></li> </ul> |

### 3.2 Technical data

Tab.1 General

|   | Boiler speed                 | Unit | POWER HT+ 1.50 | POWER HT+ 1.70 | POWER HT+ 1.90     | POWER HT + 1.110 |
|---|------------------------------|------|----------------|----------------|--------------------|------------------|
| Useful heat output at 80/60°C Heating mode            | Minimum                      | kW   | 5.0            | 7.2            | 9.4                | 11.4             |
| Useful heat output at 80/60°C Heating mode            | Maximum                      | kW   | 45             | 65             | 85                 | 102              |
| Useful heat output at 50/30 °C Heating mode           | Minimum                      | kW   | 5.4            | 7.8            | 10.2               | 12.3             |
| Useful heat output at 50/30 °C Heating mode           | Maximum                      | kW   | 48.6           | 70.2           | 91.8               | 110.2            |
| Heat input - Heating mode                             | Minimum                      | kW   | 5.1            | 7.4            | 9.7 <sup>(1)</sup> | 11.7             |
| Heat input - Heating mode                             | Maximum                      | kW   | 46.3           | 66.9           | 87.4               | 104.9            |
| Heat input - Heating mode                             | Minimum                      | kW   | 5.6            | 8.2            | 10.7               | 12.9             |
| Heat input - Heating mode                             | Maximum                      | kW   | 51.4           | 74.2           | 97.0               | 116.4            |
| Efficiency at 80/60 °C - Heating mode under full load | Maximum                      | %    | 97.4           | 97.2           | 97.3               | 97.2             |
| Efficiency at 50/30 °C -                              | Heating mode under full load | %    | 105.0          | 105.0          | 105.5              | 105.1            |
| Efficiency - - Return temperature 30°C                | Heating mode under part load | %    | 108.4          | 108.1          | 108.2              | 108.1            |

(1) The heat input with G31 gas is different and is 12.5 kW

Tab.2 Characteristics of the heating circuit

|  | Unit      | POWER HT+<br>1.50 | POWER HT+<br>1.70 | POWER HT+<br>1.90 | POWER HT+<br>1.110 |
|--|-----------|-------------------|-------------------|-------------------|--------------------|
| Water content (excluding expansion vessel) | litre     | 2.81              | 4.98              | 8.34              | 9.83               |
| Minimum operating pressure                 | MPa (bar) | 0.05 (0.5)        | 0.05 (0.5)        | 0.05 (0.5)        | 0.05 (0.5)         |
| Maximum operating pressure (MOP)           | MPa (bar) | 0.38 (3.8)        | 0.38 (3.8)        | 0.38 (3.8)        | 0.38 (3.8)         |
| Maximum water temperature                  | °C        | 85                | 85                | 85                | 85                 |
| Maximum operating temperature              | °C        | 80                | 80                | 80                | 80                 |

Tab.3 Data on the gases and combustion gases

| For gas flow rates at 15°C and 1013.25 hPA | Boiler speed | Unit   | POWER HT<br>+ 1.50 | POWER HT<br>+ 1.70 | POWER HT<br>+ 1.90 | POWER HT<br>+ 1.110 |
|--|--------------|--------|--------------------|--------------------|--------------------|---------------------|
| Consumption of natural gas (G20)           | Minimum      | m³/h   | 0.54               | 0.78               | 1.03               | 1.24                |
| Consumption of natural gas (G20)           | Maximum      | m³/h   | 4.90               | 7.07               | 9.25               | 11.10               |
| Consumption of natural gas (G25)           | Minimum      | m³/h   | 0.63               | 0.91               | 1.19               | 1.44                |
| Consumption of natural gas (G25)           | Maximum      | m³/h   | 5.69               | 8.22               | 10.75              | 12.91               |
| Consumption of Propane (G31)               | Minimum      | kg/h   | 0.40               | 0.57               | 0.97               | 0.91                |
| Consumption of Propane (G31)               | Maximum      | kg/h   | 3.59               | 5.19               | 6.79               | 8.15                |
| NOx emission according to EN297A3          | Class 5      | mg/kWh | 29.8               | 34.8               | 39.5               | 24.7                |
| Flue gas mass flow rate (G20)              | Minimum      | kg/h   | 7.2                | 14.4               | 18                 | 18                  |
| Flue gas mass flow rate (G20)              | Maximum      | kg/h   | 75.6               | 111.6              | 144                | 169.2               |
| Maximum flue gas temperature               | Minimum      | °C     | 92                 | 76                 | 70                 | 70                  |

Tab.4 Electrical characteristics

|                                    | Unit | POWER HT+<br>1.50 | POWER HT+<br>1.70 | POWER HT+<br>1.90 | POWER HT+<br>1.110 |
|------------------------------------|------|-------------------|-------------------|-------------------|--------------------|
| Power supply voltage               | VAC  | 230V 50Hz         | 230V 50Hz         | 230V 50Hz         | 230V 50Hz          |
| Maximum absorbed power - Full load | W    | 100               | 117               | 146               | 185                |
| Maximum absorbed power - Part load | W    | 24                | 24                | 24                | 24                 |
| Maximum absorbed power - Stand-by  | W    | 2.7               | 3                 | 3                 | 3                  |

Tab.5 Other characteristics

|                           | Unit | POWER HT+<br>1.50 | POWER HT+<br>1.70 | POWER HT+<br>1.90 | POWER HT+<br>1.110 |
|---------------------------|------|-------------------|-------------------|-------------------|--------------------|
| Ingress protection rating |      | IP21              | IP21              | IP21              | IP21               |
| Weight empty              | kg   | 60                | 70                | 104               | 109                |

### 3.2.1 Other technical parameters

Tab.6 Technical parameters for boiler space heaters

| Product name                          |  |  | POWER HT<br>+ 1.50 | POWER HT<br>+ 1.70 | POWER HT<br>+ 1.90 | POWER HT<br>+ 1.110 |
|---------------------------------------|--|--|--------------------|--------------------|--------------------|---------------------|
| Condensing boiler                     |  |  | Yes                | Yes                | Yes                | Yes                 |
| Low-temperature boiler <sup>(1)</sup> |  |  | No                 | No                 | No                 | No                  |
| B1 boiler                             |  |  | No                 | No                 | No                 | No                  |
| Cogeneration space heater             |  |  | No                 | No                 | No                 | No                  |
| Combination heater                    |  |  | No                 | No                 | No                 | No                  |

| Product name   |                 |        | POWER HT + 1.50 | POWER HT + 1.70 | POWER HT + 1.90 | POWER HT + 1.110 |
|--|-----------------|--------|-----------------|-----------------|-----------------|------------------|
| <b>Rated heat output</b>   | $P_{rated}$     | kW     | 45              | 65              | 85              | 102              |
| Useful heat output at rated heat output and high temperature regime <sup>(2)</sup>   | $P_4$           | kW     | 45.0            | 65.0            | 85.0            | 102.0            |
| Useful heat output at 30% of rated heat output and low temperature regime <sup>(1)</sup>   | $P_1$           | kW     | 15.0            | 21.7            | 28.3            | 34.0             |
| <b>Seasonal space heating energy efficiency</b>  | $\eta_s$        | %      | 93              | 93              | -               | -                |
| Useful efficiency at rated heat output and high temperature regime <sup>(2)</sup>  | $\eta_4$        | %      | 87.7            | 87.6            | 87.7            | 87.6             |
| Useful efficiency at 30% of rated heat output and low temperature regime <sup>(1)</sup>  | $\eta_1$        | %      | 97.7            | 97.4            | 97.5            | 97.4             |
| <b>Auxiliary electricity consumption</b>   |                 |        |                 |                 |                 |                  |
| Full load  | $e_{lmax}$      | kW     | 0.100           | 0.117           | 0.146           | 0.185            |
| Part load  | $e_{lmin}$      | kW     | 0.023           | 0.024           | 0.024           | 0.024            |
| Stand-by   | $P_{SB}$        | kW     | 0.003           | 0.003           | 0.003           | 0.003            |
| <b>Other characteristics</b>   |                 |        |                 |                 |                 |                  |
| Standby heat loss  | $P_{stby}$      | kW     | 0.055           | 0.059           | 0.066           | 0.070            |
| Ignition burner power consumption  | $P_{ign}$       | kW     | -               | -               | -               | -                |
| Annual energy consumption  | $Q_{HE}$        | GJ     | 139             | 201             | -               | -                |
| Sound power level, indoors   | $L_{WA}$        | dB     | 61              | 64              | -               | -                |
| Emissions of nitrogen oxides   | NO <sub>x</sub> | mg/kWh | 27              | 31              | 36              | 22               |
| (1) Low temperature means for condensing boilers 30°C, for low temperature boilers 37°C and for other heaters 50°C return temperature (at heater inlet). |                 |        |                 |                 |                 |                  |
| (2) High temperature regime means 60°C return temperature at heater inlet and 80°C feed temperature at heater outlet.                                    |                 |        |                 |                 |                 |                  |



**See**  
The back cover for contact details.

### 3.2.2 Sensor specifications

Tab.7 Heating flow sensor and return sensor

|                      |      |      |      |
|----------------------|------|------|------|
| Temperature (in °C)  | 30   | 65   | 85   |
| Resistance (in ohms) | 8059 | 2084 | 1070 |

Tab.8 Flue gas sensor

|                      |          |        |       |       |      |     |     |     |
|----------------------|----------|--------|-------|-------|------|-----|-----|-----|
| Temperature (in °C)  | -50      | -10    | 0     | 40    | 100  | 200 | 250 | 300 |
| Resistance (in ohms) | 1 755765 | 117521 | 67650 | 10569 | 1377 | 145 | 65  | 34  |

Tab.9 Outside sensor

|                      |       |      |      |      |      |      |     |     |
|----------------------|-------|------|------|------|------|------|-----|-----|
| Temperature (in °C)  | -30   | -15  | -5   | 0    | 10   | 20   | 30  | 50  |
| Resistance (in ohms) | 13034 | 5861 | 3600 | 2857 | 1840 | 1218 | 827 | 407 |

## 4 Description of the product

### 4.1 General description

POWER HT + floor-standing condensing gas boilers have the following characteristics:

- Low pollutant emissions
- High efficiency heating
- Electronic control panel
- Flue gas discharge by a forced flue, chimney or bi-flow type connection.
- Perfectly suitable for cascade systems with several boilers.

### 4.2 Operating principle

#### 4.2.1 Circulation pump



##### Note

The benchmark for the most efficient circulators is  $EEL \leq 0.20$ .

#### 4.2.2 Gas/air setting

The casing fitted to the boiler is also used as an air box. Air is drawn in by the fan and gas injected into the Venturi by the fan intake. The fan speed is modulated according to the settings, the heat demand and the actual temperatures measured by the temperature sensors. The gas and air are mixed in the Venturi. The gas/air ratio command function accurately adjusts the quantities of gas and air required. This provides optimum combustion over the entire output range. The gas/air mixture is sent to the burner, located upstream of the heat exchanger.

#### 4.2.3 Low-loss header (accessory)

The low-loss header is used to prevent interaction between the dynamic pressures within the boiler and the heating circuits. The low-loss header considerably reduces the variations in pressure and flow rate caused by the use of several circulating pumps in an installation and is used to manage flows in the installation and to control temperatures.

Fig.2 Boiler equipped with the low-loss header kit

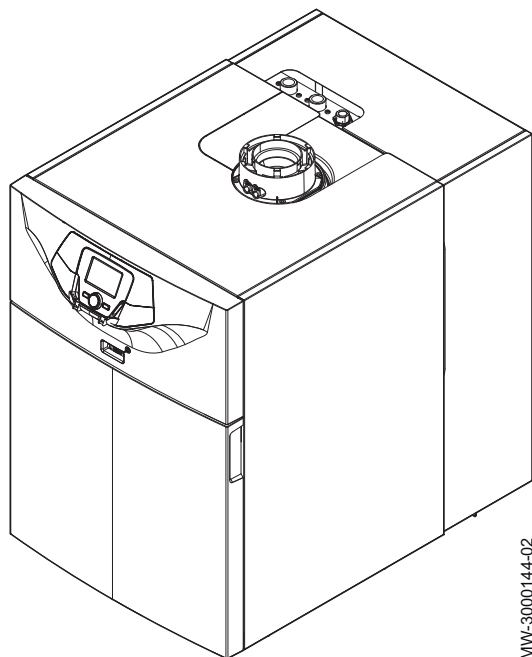

MW-3000144-02

Fig.3 Functional diagram of a boiler with a low-loss header

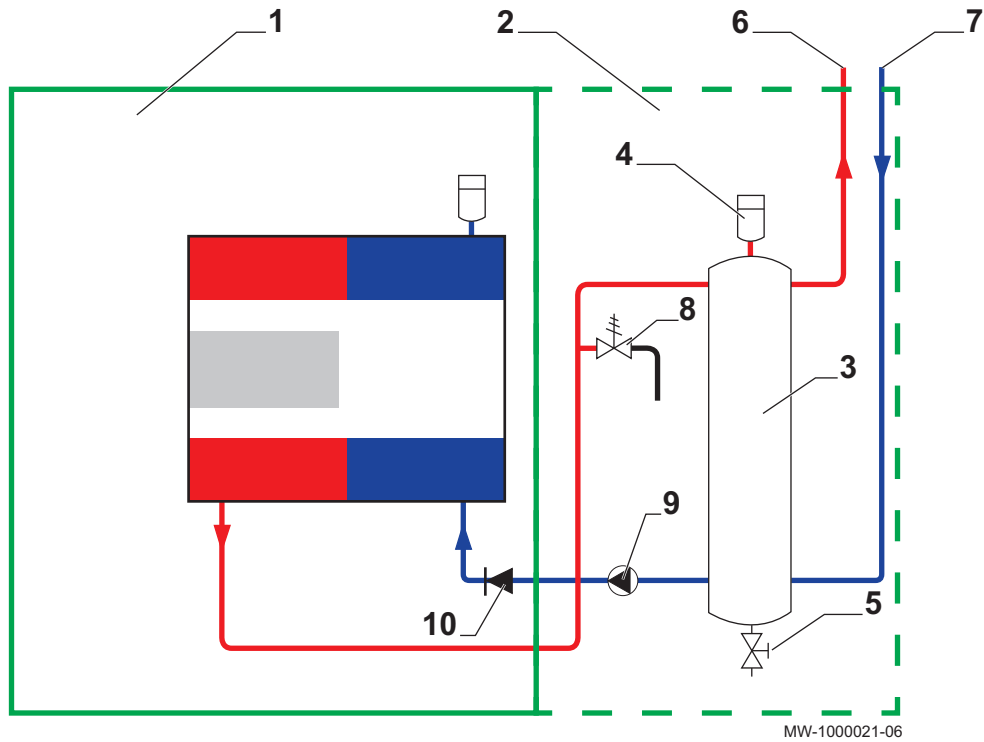

- |                               |                               |
|-------------------------------|-------------------------------|
| 1 Boiler                      | 6 Heating circuit flow        |
| 2 Low-loss header kit         | 7 Heating circuit return      |
| 3 Low-loss header (accessory) | 8 Safety valve                |
| 4 Air vent                    | 9 Modulating circulating pump |
| 5 Drain valve                 | 10 Non-return valve           |

#### 4.2.4 System in cascade

Fig.4 Boilers in cascade

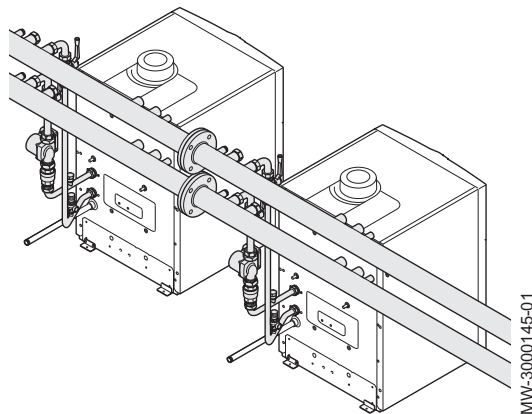

The boiler is ideally suited for a cascade system configuration. Use a boiler/cascade connection kit to connect boilers in cascade.

**i Note** Please contact the After Sales Service for further information.

#### 4.2.5 Settings and safety devices



##### Note

The settings and safety devices are only operational if the boiler is powered up.

Tab.10 Description of the safety devices

| Device   | Description   |
|--|---|
| Safety thermostats                             | <p>The safety thermostats suspend the supply of gas to the burner if the water in the primary circuit overheats. To resume normal operation of the boiler, eliminate the cause of this interruption.</p> <p> <b>Caution</b><br/>The safety thermostats must in no circumstances be switched off or disconnected.</p> |
| NTC flue gas sensor                            | The control panel blocks the gas supply to the burner in the event of overheating. To resume normal operation of the boiler, switch off the boiler and switch it back on again with the ON/OFF switch.  |
| Flame detector by ionisation                   | The boiler is put into safety shut-down in the event of gas shortage or incomplete inter-ignition on the burner.  |
| Hydraulic pressure switch                      | <p>Thanks to this device, the burner can only operate if the system pressure is higher than 0.5 bar (0.05 MPa).</p> <p>When the pressure switch detects a pressure lower than 0.8 bar (0.08 MPa), a warning message is displayed, without stopping the circulating pump.</p>  |
| Post-circulating pump                          | After the burner stops, depending on the room thermostat setting and if in heating mode, the circulating pump runs for a further 3 minutes.   |
| Frost protection device                        | <p>When the flow temperature is lower than 5°C, the burner starts up and runs until the flow temperature reaches 15°C. This device runs under the following conditions:</p> <ul style="list-style-type: none"> <li>• The boiler is switched on</li> <li>• The gas supply is working</li> <li>• The pressure in the system is higher than 0.5 bar (0,05 MPa)</li> </ul>                                |
| Anti-blocking of the pump                      | <p>If there are no heating or domestic hot water requirements for 24 consecutive hours, the pumps start up automatically and run for 10 seconds.</p> <p>The pumps connected directly to the appliance's terminal blocks are started up every Friday at 10:00 a.m. and run for 30 seconds.</p>   |
| Anticipatory start-up of the circulating pumps | In heating mode only, the appliance can start up the circulating pumps before burner ignition. The duration and activation of anticipatory start-up depends on the conditions of installation and the operating temperatures. The duration of anticipatory start-up of the circulating pumps therefore varies from a few seconds to several minutes.  |

### 4.3 Main components

Fig.5 POWER HT+ 1.50 and POWER HT+ 1.70

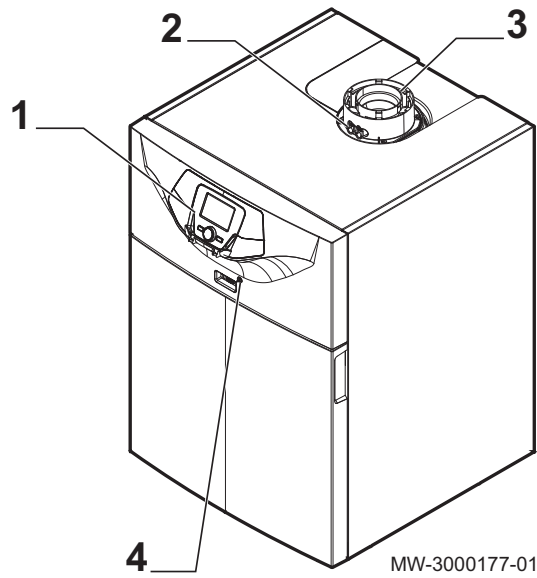

- 1 Control panel
- 2 Flue gas measuring point
- 3 Flue gas connection
- 4 On/Off button

Fig.6 POWER HT+ 1.90 and POWER HT+ 1.110

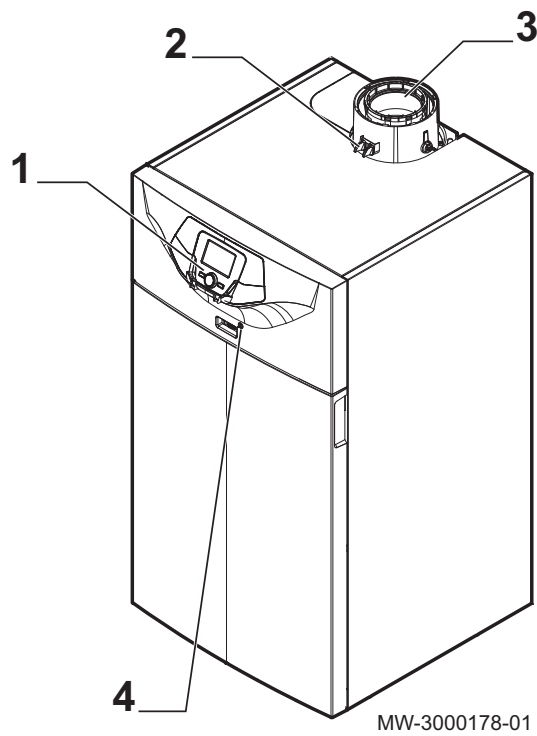

- 1 Control panel
- 2 Flue gas measuring point
- 3 Flue gas connection
- 4 On/Off button



## 4.4 Control panel description

Fig.7 Control panel keys

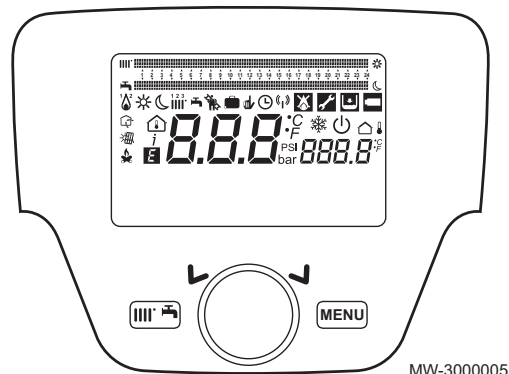
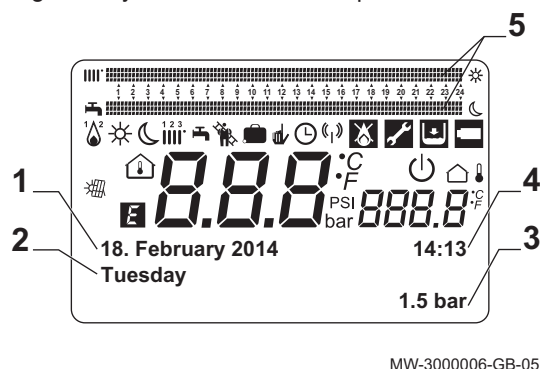















Fig.8 Symbols on the control panel



### 4.4.1 Description of the keys















-  Operating mode key  
This key is used to access the shortcuts menu
-  Menu key
-  Rotary selection and confirmation button

### 4.4.2 Description of the symbols

-  Burner lit
  -  (1): Output < 70%
  -  (2): Output > 70%
-  Operating mode: Comfort room temperature
-  Operating mode: Reduced room temperature
-  Operating mode: Heating
  -  (1): Zone 1 active
  -  (2): Zone 2 active
  -  (3): Zone 3 active
-  Operating mode: Domestic hot water activated

#### Note

The domestic hot water  can be activated. The heating  is then deactivated.

-  Sweep Function activated
-  Holidays program function activated
-  Operating mode: Manual
-  Operating mode: Automatic
-  Data transmission: only when the wireless device is connected.
-  Error: the burner cannot start up
-  Error: After Sales Service intervention required
-  Hydraulic pressure too low
-  Room temperature (°C)
-  Temperature and hydraulic pressure units: international system or imperial system.
-  Protection Mode active: the boiler's frost protection is activated.
-  Outside temperature (°C)
-  Solar integration available
-  Generic error
- 1** Date: day, month, year
- 2** Day of the week
- 3** Boiler / heating circuit pressure
- 4** Clock: hours and minutes
- 5** Comfort period indicators over 24 hours in Domestic Hot Water mode and Heating mode

## 5 Operation

### 5.1 Use of the control panel

Fig.9 Accessing the User parameters

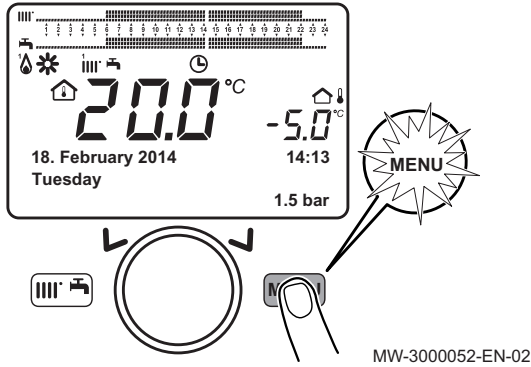

#### 5.1.1 Modifying the user parameters

1. Press the key to access the parameters.



**Note**

Press the key to return to the main display.

The user parameters can now be accessed. Use the button to select and modify them.



**For more information, see**  
List of parameters, page 20

### 5.2 Starting up the boiler

Fig.10 Putting the boiler into operation

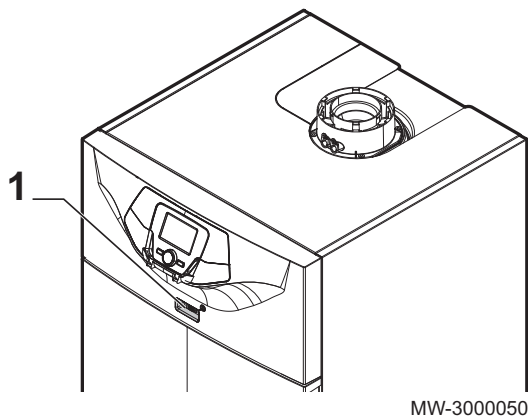

1. Start up the boiler by pressing the ON/OFF switch.
2. Open the gas cock.
3. Press the key to access the shortcuts menu.
4. Select the **Standby/operation** parameter by turning the button.
5. Press the button to start up the boiler.  
The symbol disappears.

### 5.3 Stopping the boiler



**Note**

Choose the operating mode **Off** or **Standby**.

1. Switch off the boiler by pressing the ON/OFF switch.
2. Close the gas cock.

#### 5.3.1 Putting the boiler in Standby mode

1. Press the key to access the shortcuts menu.
2. Select the **Standby/operation** parameter by turning the button.
3. Press the button to put the boiler in standby.  
The symbol is displayed.

### 5.4 Frost Protection

The electronic management system of the boiler includes protection against frost. If the water temperature falls below 5°C, the burner starts up in order to provide a water temperature of 30°C.

This function only works if the boiler is turned on, the gas supply open and the hydraulic pressure correct.

Fig.11 Shortcuts menu

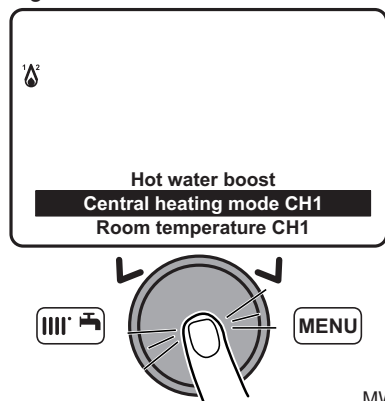

MW-300051-EN-02

### 5.4.1 Activating the Off

1. Press the key to access the shortcuts menu.
2. Select the parameter **Central heating mode CH1** by turning the button.
3. Confirm the selection by pressing the button.
4. Select the parameter **Off** by turning the button.
5. Confirm the selection by pressing the button.  
The symbol is displayed.



#### Note

When the operating mode **Off** is activated:













- The electrical circuits continue to be powered up.
- The frost protection function is activated.

## 6 Settings

### 6.1 List of parameters

#### 6.1.1 Shortcuts menu



Tab.11 Functions accessible with the shortcut key 

| Parameter                | Description                                 | Adjustment range  |
|--------------------------|---|---|
| Standby/operation        | Boiler standby / start-up                   | <ul style="list-style-type: none"> <li>• <b>Standby</b> : Boiler put on standby. <ul style="list-style-type: none"> <li>- The symbol  is displayed.</li> <li>- The boiler's operating modes are deactivated.</li> <li>- The frost protection function is activated.</li> </ul> </li> <li>• <b>On</b> : Putting the boiler into operation</li> </ul>  |
| 316:Hot water boost      | Forcing domestic hot water production.      | <ul style="list-style-type: none"> <li>• <b>On</b> : <ul style="list-style-type: none"> <li>- Activates forcing of domestic hot water.</li> <li>- The symbol  is displayed.</li> <li>- If a domestic hot water tank is connected to the boiler circuit, the boiler will give priority to forcing heating of the DHW tank, independently of the other parameters.</li> </ul> </li> <li>• <b>Off</b> : Deactivates forcing of domestic hot water.</li> </ul>   |
| Central heating mode CH1 | Boiler operating mode.                      | <ul style="list-style-type: none"> <li>• <b>On</b> : <ul style="list-style-type: none"> <li>- Heating is always activated.</li> <li>- The symbols ,  and  are displayed.</li> </ul> </li> <li>• <b>Reduced</b> : <ul style="list-style-type: none"> <li>- Heating is deactivated.</li> <li>- The symbols ,  and  are displayed.</li> </ul> </li> <li>• <b>Timed</b> : <ul style="list-style-type: none"> <li>- Heating is dependent on the time range programmed.</li> <li>- The symbols  and  are displayed.</li> </ul> </li> <li>• <b>Off</b> : <ul style="list-style-type: none"> <li>- The boiler is shut down and frost protection is active.</li> <li>- The symbol  is displayed.</li> </ul> </li> </ul> |
| Room temperature CH1     | Room temperature set point in comfort mode. |   |
| Hot water heating        | Setting domestic hot water production.      | <ul style="list-style-type: none"> <li>• <b>On</b> : Enables domestic hot water production.</li> <li>• <b>Off</b> : <ul style="list-style-type: none"> <li>- Disables domestic hot water production.</li> <li>- The symbol  disappears from the display.</li> </ul> </li> <li>• <b>Eco</b> : Not used.</li> </ul>  |
| Hot water temp setpoint  | Domestic hot water temperature set point.   |   |

#### 6.1.2 Information menu

Tab.12 Menu Information

| Information          | Description   | Value |
|----------------------|---|-------|
| Room temperature     | Is displayed if the control system unit is configured as a room temperature appliance |       |
| Room temperature min |   |       |
| Room temperature max |   |       |
| Boiler temperature   | Boiler flow temperature   | °C    |
| Outside temp         | Outside temperature   | °C    |

| Information                       | Description  | Value |
|-----------------------------------|--|-------|
| Outside temp min                  | Minimum outside temperature value memorised<br> <b>Note</b><br>The outside sensor must be connected.                                    | °C    |
| Outside temp max                  | Maximum outside temperature value memorised<br> <b>Note</b><br>The outside sensor must be connected.                                    | °C    |
| Hot water temp 1                  | Domestic hot water temperature<br> <b>Note</b><br>The value displayed comes from the sensor on the boiler's domestic hot water circuit. | °C    |
| Collector temp 1                  | Instantaneous temperature of the solar panel sensor (when associated to a solar system)  | °C    |
| State central heating CH1         | Operating mode of heating circuit 1  |       |
| State central heating CH2         | Operating mode of heating circuit 2  |       |
| State central heating CH3         | Operating mode of heating circuit 3  |       |
| State hot water                   | Domestic hot water circuit operating mode  |       |
| State boiler                      | Boiler operating mode  |       |
| State solar                       | Indicates solar running (when associated to a solar system)  | -     |
| <b>Telephone customer service</b> | Telephone number of the After Sales Service  | No.   |

### 6.1.3 List of user parameters

Tab.13 Menu **Set time and date**

| Parameter number | Parameter       | Description                   |
|------------------|-----------------|-------------------------------|
| 1                | Hours / minutes | Setting the time              |
| 2                | Day / month     | Setting the day and the month |
| 3                | Year            | Setting the year              |

Tab.14 Menu **Operator section**

| Parameter number | Parameter        | Description   | Factory setting |
|------------------|------------------|---|-----------------|
| 20               | Change Language  | Setting the interface language  | English         |
| 27               | Programming lock | Setting the programming lock<br><ul style="list-style-type: none"> <li>• Off : the parameters can be displayed and modified</li> <li>• On : the parameters can be displayed but cannot be modified</li> </ul> | Off             |

Tab.15 Menu **Time program**

| Parameter number  |                   |                   | Parameter    | Description  |
|-------------------|-------------------|-------------------|--------------|--|
| Heating circuit 1 | Heating circuit 2 | Heating circuit 3 |              |  |
| 500               | 520               | 540               | Select days  | Selecting the days or group of days for the timer program. |
| 514               | 534               | 554               | Mon-Sun      | Selecting a default timer program.                         |
| 501               | 521               | 541               | 1st Time ON  | Start of timer period 1.                                   |
| 502               | 522               | 542               | 1st Time OFF | End of timer period 1.                                     |
| 503               | 523               | 543               | 2nd Time ON  | Start of timer period 2.                                   |
| 504               | 524               | 544               | 2nd Time OFF | End of timer period 2.                                     |

| Parameter number  |                   |                   | Parameter      | Description                                       |
|-------------------|-------------------|-------------------|----------------|---|
| Heating circuit 1 | Heating circuit 2 | Heating circuit 3 |                |   |
| 505               | 525               | 545               | 3rd Time ON    | Start of timer period 3.                          |
| 506               | 526               | 546               | 3rd Time OFF   | End of timer period 3.                            |
| 516               | 536               | 556               | Default values | Reset the timer programming parameters (Yes / No) |

Tab.16 Menu Time hot water

| Parameter number | Parameter      | Description  |
|------------------|----------------|--|
| 560              | Select days    | Selecting the days or group of days for the timer program. |
| 574              | Mon-Sun        | Selecting a default timer program.                         |
| 561              | 1st Time ON    | Start of timer period 1.                                   |
| 562              | 1st Time OFF   | End of timer period 1.                                     |
| 563              | 2nd Time ON    | Start of timer period 2.                                   |
| 564              | 2nd Time OFF   | End of timer period 2.                                     |
| 565              | 3rd Time ON    | Start of timer period 3.                                   |
| 566              | 3rd Time OFF   | End of timer period 3.                                     |
| 576              | Default values | Reset the timer programming parameters (Yes / No).         |

Tab.17 Menu Holiday Settings

| Parameter number  |                   |                   | Parameter       | Description   | Factory setting |
|-------------------|-------------------|-------------------|-----------------|---|-----------------|
| Heating circuit 1 | Heating circuit 2 | Heating circuit 3 |                 |   |                 |
| 641               | 651               | 661               | Select          | Selecting the holiday period  | Period 1        |
| 642               | 652               | 662               | Start           | Selecting the day and month of the start of the current holiday period.   |                 |
| 643               | 653               | 663               | End             | Selecting the day and month of the end of the current holiday period.   |                 |
| 648               | 658               | 668               | Operating level | Boiler operating mode during the holiday period. <ul style="list-style-type: none"> <li>• Off</li> <li>• Reduced</li> </ul> | Off             |

Tab.18 Menu Temps / mode CH1 – Temps / mode CH2 – Temps / mode CH3

| Parameter number  |                   |                   | Parameter      | Description   | Factory setting |
|-------------------|-------------------|-------------------|----------------|---|-----------------|
| Heating circuit 1 | Heating circuit 2 | Heating circuit 3 |                |   |                 |
| 700               | 1000              | 1300              | Operating mode | <p>The control unit is installed on the boiler:</p> <ul style="list-style-type: none"> <li>• Off : heating is deactivated.</li> <li>• Timed : heating is dependent on the timer program.</li> <li>• Reduced : heating is in permanent reduced mode.</li> <li>• On : heating is in permanent comfort mode.</li> </ul> <p>The control unit is installed as a room temperature control system:</p> <ul style="list-style-type: none"> <li>• Off : the boiler starts up when the room temperature falls below the frost protection set point.</li> <li>• Timed : heating is dependent on the timer program.</li> <li>• Reduced : the room temperature set point is the reduced set point (parameters 712, 1010, 1310)</li> <li>• On : the room temperature set point is the comfort set point (parameters 710, 1010, 1310)</li> </ul> | On              |

| Parameter number  |                   |                   | Parameter             | Description | Factory setting |
|-------------------|-------------------|-------------------|-----------------------|-------------|-----------------|
| Heating circuit 1 | Heating circuit 2 | Heating circuit 3 |                       |             |                 |
| 710               | 1010              | 1310              | Comfort setpoint      |             | 20°C            |
| 712               | 1012              | 1310              | Reduced temp setpoint |             | 16°C            |

## 6.2 Setting the parameters

### 6.2.1 Setting the date and time

Fig.12 Access to parameters

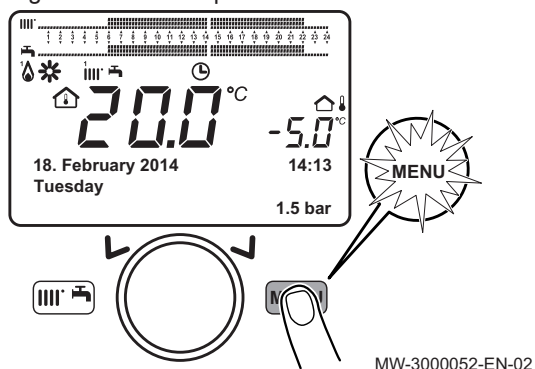

1. Press the key to access the parameters.

Fig.13 Menu selection

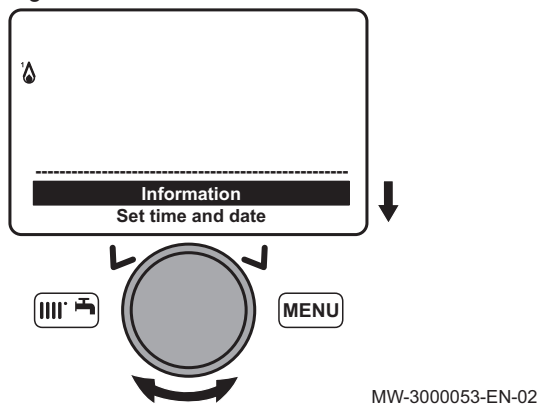

2. Select the **Set time and date** menu by turning the button.

Fig.14 Time / Date parameter

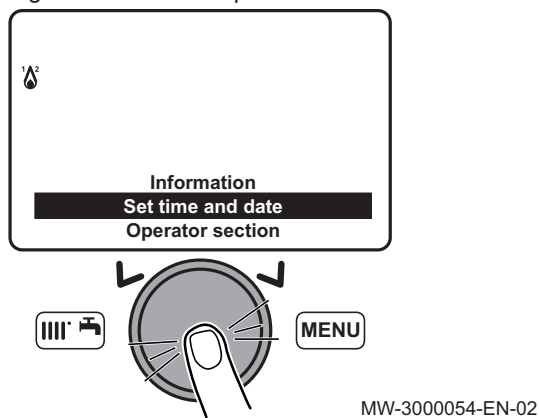

3. Confirm the menu selection by pressing the button . The parameter **Hours / minutes** appears.

Fig.15 Modification possible prior to confirmation

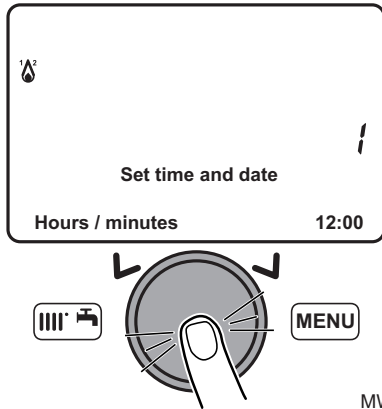

MW-3000055-EN-02

4. Confirm the parameter selection by pressing the button. The parameter flashes, it can be modified.
5. Modify the parameter by turning the button.
6. Confirm the setting by pressing the button.
7. Set the other settings parameters if necessary.

**Note**  
Press the key to return to the main display.

**For more information, see**  
List of user parameters, page 21

### 6.2.2 Language Selection

Fig.16 Selecting the Info Menu

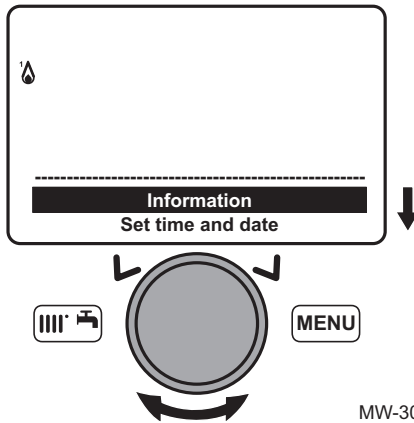

MW-3000056-EN-02

1. Press the key to access the parameters.
2. Select the **Operator section** menu by turning the button.

Fig.17 Selecting the User Interface parameter

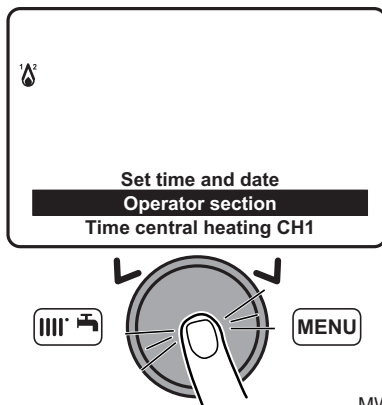

MW-3000057-EN-02



3. Confirm the menu selection by pressing the button . The **Change Language** parameter appears.

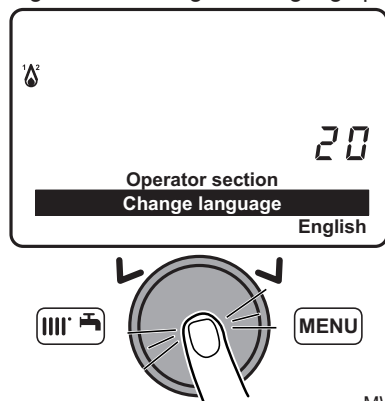

Fig.18 Selecting the Language parameter



MW-3000058-EN-02

4. Confirm the menu selection by pressing the button .
5. The language currently used flashes.
6. Modify the parameter by turning the  button.
7. Confirm the setting by pressing the .

**Note**Press the  key to return to the main display.

Fig.19 Confirming the selected temperature

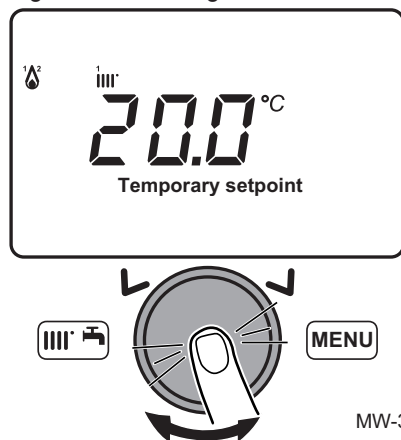

MW-3000143-EN-02



1. From the control panel main screen, turn the  button to increase or reduce the temperature value.
2. Confirm the menu selection by pressing the button .

Fig.20 Selecting the Regime CH1 parameter



MW-3000059-EN-02

**6.2.4 Changing the operating mode**

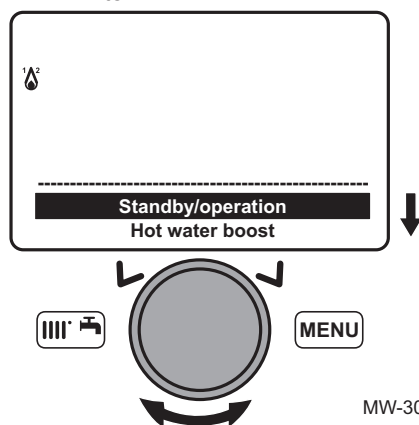

1. Press the  key to access the shortcuts menu.
2. Select the parameter **Central heating mode CH1** by turning the  button.
3. Press the  button to confirm.

Fig.21 Confirming the operating mode selected



MW-3000060-EN-02

4. Select the appropriate operating mode.
5. Press the button to confirm.

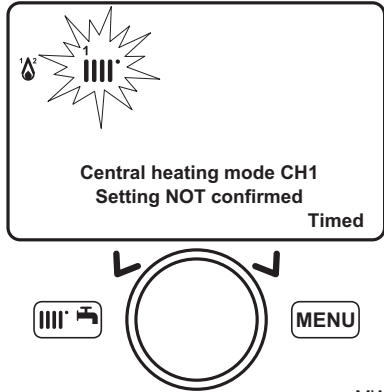

**Note**  
Press the key to return to the main display.



**For more information, see**  
Shortcuts menu, page 20

Fig.22 Parameter selection 316:Hot water boost

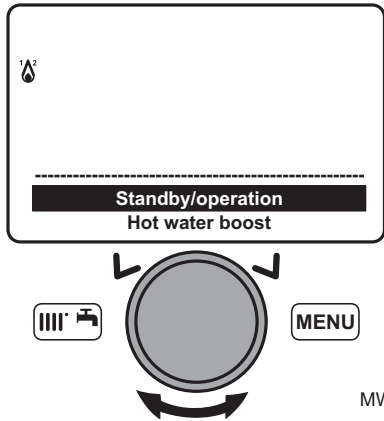

MW-3000061-EN-02

1. Press the key to access the shortcuts menu.
2. Select the parameter **316:Hot water boost** by turning the button.
3. Press the button to start forcing domestic hot water.



**Note**  
Press the button a second time to stop forcing domestic hot water.



**Note**  
Press the key to return to the main display.



**For more information, see**  
Shortcuts menu, page 20

Fig.23 Selecting the parameter Room temperature CH1

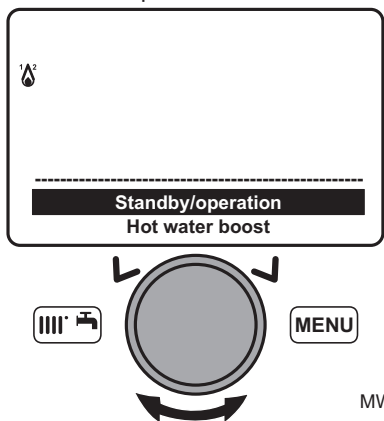

MW-3000062-EN-02

### 6.2.6 Setting the room temperature set point (Onmode)

1. Press the key to access the shortcuts menu.
2. Select the parameter **Room temperature CH1** by turning the button.
3. Press the button to confirm.

Fig.24 Modification of the temperature set point

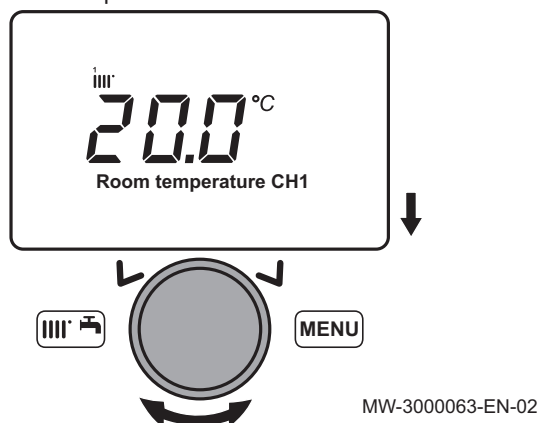

4. Turn the button to modify the temperature set point.
5. Press the button to confirm.

**Note**  
Press the key to return to the main display.

**For more information, see**  
Shortcuts menu, page 20

### 6.2.7 Modifying the domestic hot water production mode

Fig.25 Selecting the parameter Hot water heating

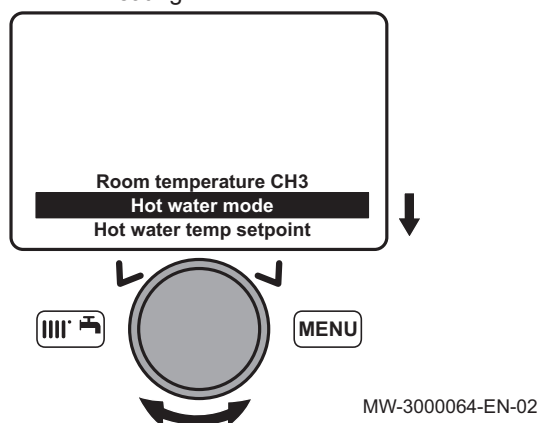

1. Press the key to access the shortcuts menu.
2. Select the parameter **Hot water heating** by turning the button.
3. Press the button to confirm.
4. Select the appropriate operating mode.
5. Press the button to confirm.

**Note**  
Press the key to return to the main display.

**For more information, see**  
Shortcuts menu, page 20

Fig.26 Selecting the parameter Hot water temp setpoint

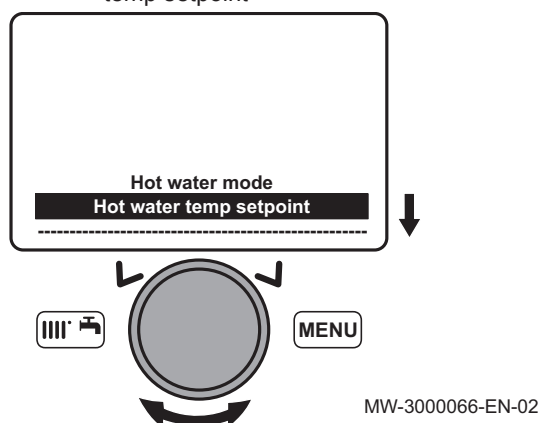

1. Press the key to access the shortcuts menu.
2. Select the parameter **Hot water temp setpoint** by turning the button.
3. Press the button to confirm.

Fig.27 Modification of the temperature set point

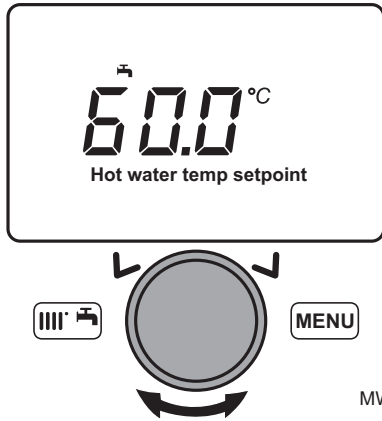

MW-3000067-EN-02

4. Turn the button to modify the temperature set point.
5. Press the button to confirm.



**Note**

Press the key to return to the main display.



**For more information, see**  
Shortcuts menu, page 20

Fig.28 Selecting the menu Temps / mode CH1

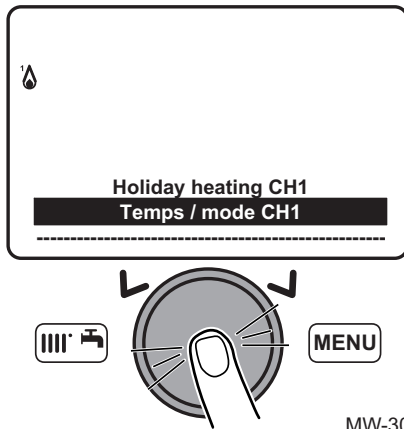

MW-3000068-EN-03

1. Press the key to access the parameters.
  2. Select the **Temps / mode CH1** menu by turning the button.
  3. Confirm the menu selection by pressing the button .
- The parameter **Operating mode** appears.

Fig.29 Selecting the menu Reduced temp setpoint

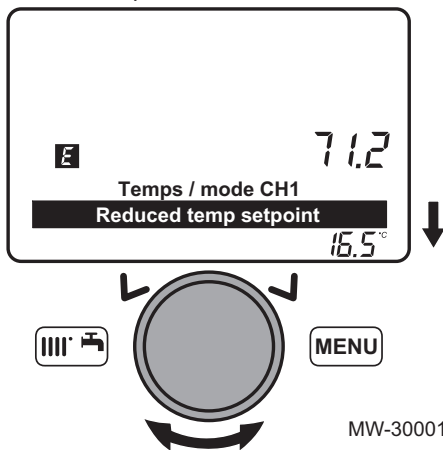

MW-3000129-EN-02

4. Select the **Reduced temp setpoint** menu by turning the button.
  5. Confirm the menu selection by pressing the button .
- The room temperature set point (Reducedmode) flashes.

Fig.30 Modification of the temperature set point

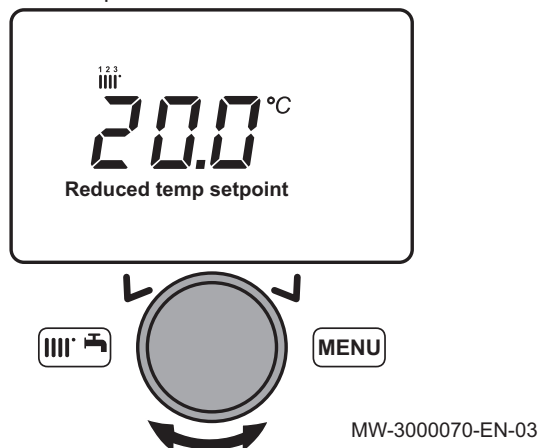

6. Turn the button to modify the temperature set point.
7. Press the button to confirm.

**Note**  
Press the key to return to the main display.

### 6.2.10 Programming a Holiday period

This series of functions is used to program the boiler's behaviour in holiday periods or during prolonged absences. The various parameters are used to program one of eight Holiday periods.

**Note**  
When the function is activated, the symbol is displayed.

1. Press the key to access the parameters.
2. Select the **Holiday heating CH1** menu by turning the button.

Fig.31 Menu selection Holiday heating CH1

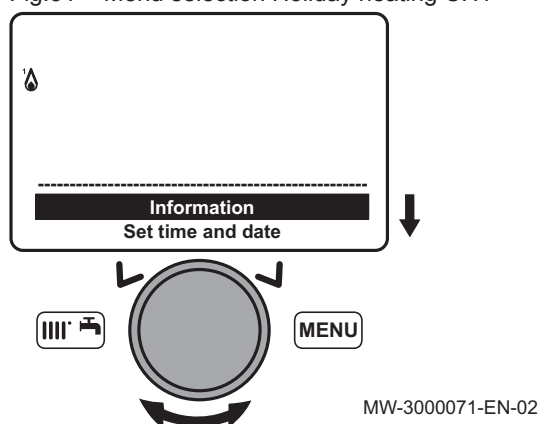
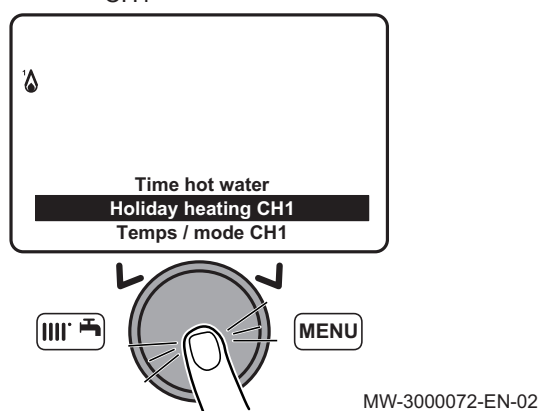

Fig.32 Confirming the menu Holiday heating CH1



3. Confirm the menu selection by pressing the button . The **Select** parameter appears.

Fig.33 Selecting the holiday period

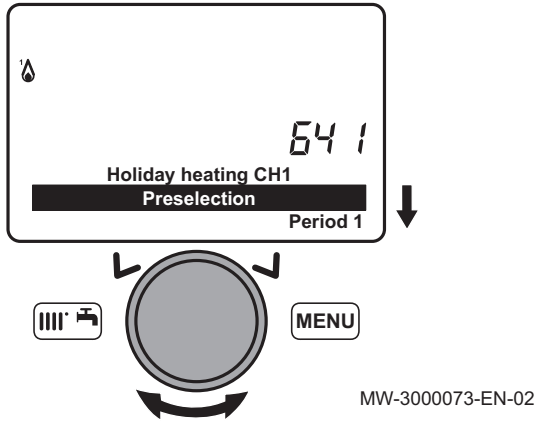

Fig.34 Confirming the holiday period selected

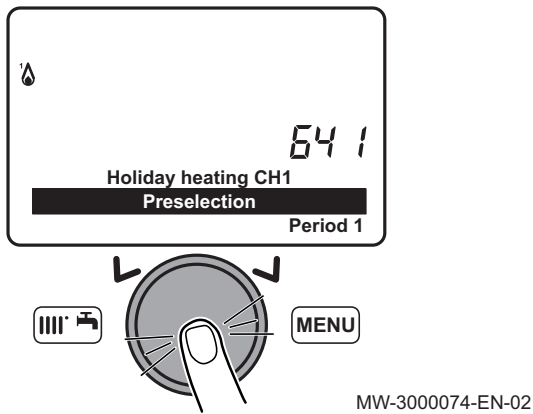

Fig.35 Confirming the period selected

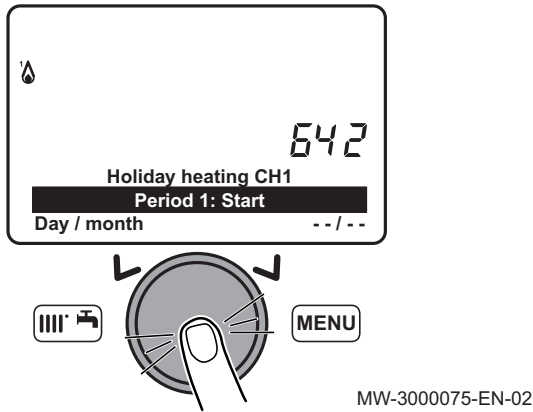
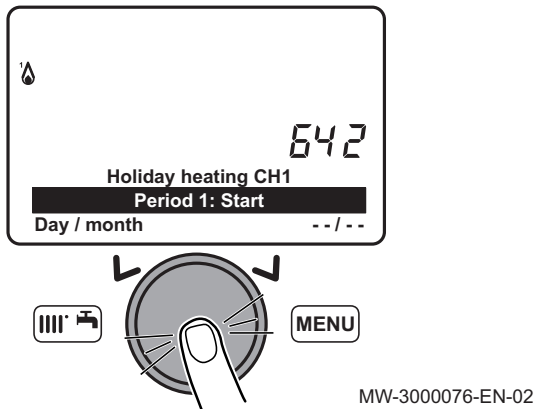

Fig.36 Confirming the start date of the holiday period



4. Select the Holiday period to be programmed by turning the button.

5. Confirm by pressing the button.

6. Select the **Start** parameter by turning the button.

7. Confirm the menu selection by pressing the button .

8. Select and confirm the start date of the holiday period with the button.

9. Confirm the menu selection by pressing the button .

Fig.37 Selecting the end date of the holiday period

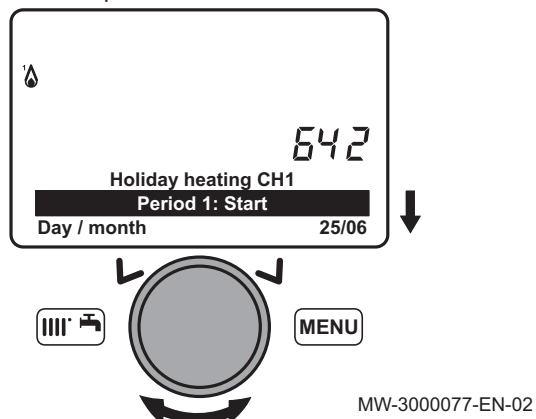

Fig.38 Confirming the end date of the holiday period

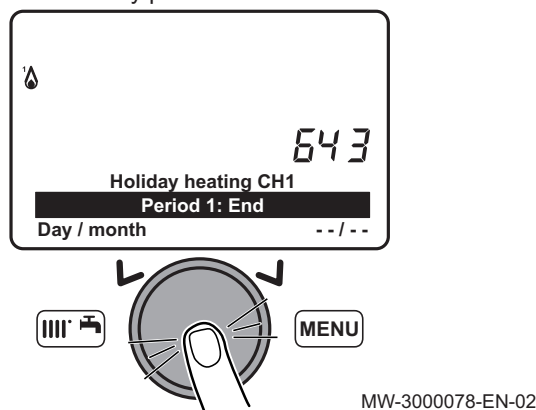

Fig.39 Selecting the parameter Operating level

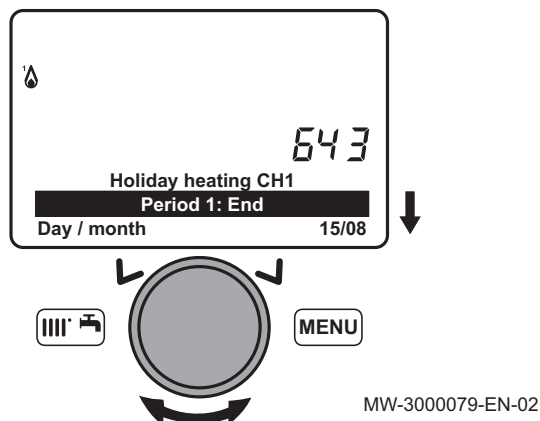
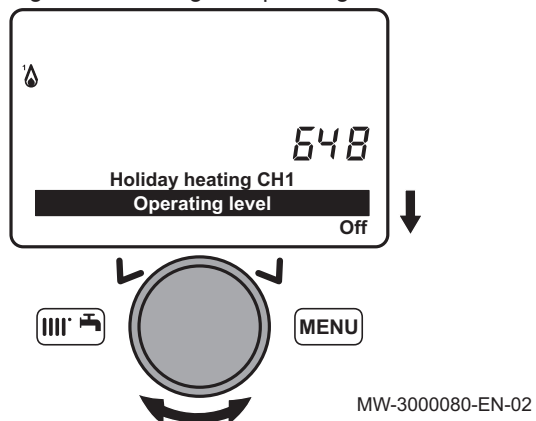



Fig.40 Selecting the operating mode



10. Select the **End** parameter by turning the  button.

11. Select and confirm the end date of the holiday period with the  button.

12. Confirm the menu selection by pressing the button .

13. Select the **Operating level** parameter by turning the  button.

14. Confirm the menu selection by pressing the button .

15. Select the boiler's operating mode during the holiday period by turning the  button.

16. Confirm the menu selection by pressing the button .



**For more information, see**

- Setting the room temperature set point (Onmode), page 26
- Setting the room temperature set point (Reduced mode), page 28
- Activating the Off, page 19

**6.2.11 Selecting a heating circuit**

The control panel can manage up to three different heating circuits.

1. From the home screen, turn the button to select one of the three heating circuits available.
2. Press the button to confirm.
3. Turn the button to temporarily modify the temperature set point on the selected heating circuit.
4. Press the button to confirm.  
The selected heating circuit is active.

**6.3 Accessing the information menu**

Fig.41 Selecting the menu Information

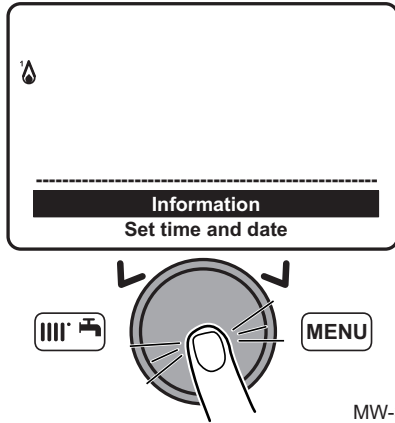

MW-3000098-EN-02

Fig.42 Selecting the various items of information

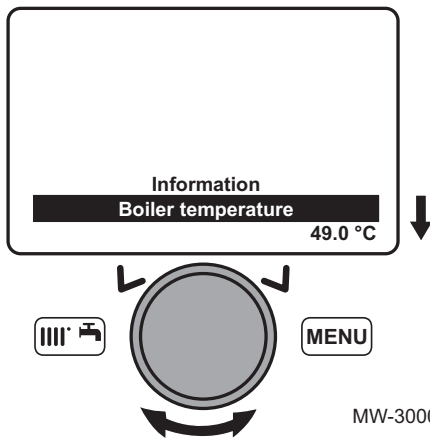

MW-3000099-EN-02

1. Go to the parameters menu by pressing the key.
2. Select the Information menu with the rotary button .
3. Confirm by pressing the rotary button .

4. Use the rotary button to scroll through the various items of information.



**For more information, see**

Information menu, page 20



## 7 Maintenance

### 7.1 General

---

We recommend having the boiler inspected and serviced at regular intervals.

- Boiler maintenance and cleaning must be carried out at least once a year by a qualified professional.
- Have an inspection carried out and the flues swept **at least once a year** or more, depending on the regulations in force in your country.

**Caution**

Failure to service the appliance voids the warranty.

**Caution**

Maintenance work must be carried out by a qualified professional.

**Caution**

Only genuine spare parts may be used.

## 8 Troubleshooting

### 8.1 Error codes

Fig.43 Error code

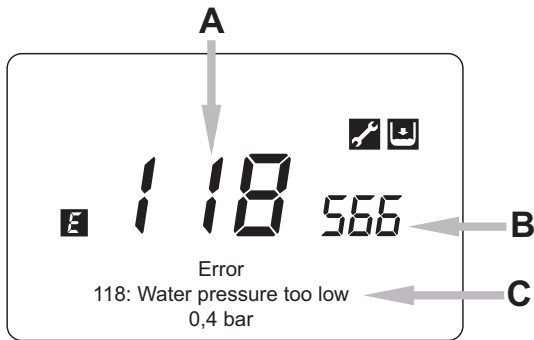

BM-000026-GB-03

- A Error code
- B Secondary error code
- C Description of the error



**Note**

Press the key to return to the main display.

- The **E** symbol continues to be displayed on the control panel.
- If the error is not resolved after one minute, the error code is displayed on the control panel a second time.

Tab.19 List of error codes

| <b>E</b> | Display                     | Description of the error  |
|----------|-----------------------------|---|
| 10       | 10:Outside sensor           | Outside temperature sensor.   |
| 50       | 50:HW sensor 1              | Domestic hot water sensor (only for heating only models with domestic hot water tank).  |
| 110      | 110:Lockout SLT             | Safety thermostat cut-off for overheating (pump blocked or air in the heating circuit). |
| 111      | 111:Shutdown limit thermost | Safety thermostat cut-off for overheating.  |
| 133      | 133:Safety time exceeded    | Ignition error (4 attempts).  |



**Note**

Contact the installer:

- If an error code different from the ones described is displayed on the screen
- If an error code is displayed on a regular basis



**Note**

If the error code simultaneously displays the and symbols, contact the accredited technical assistance service.

**Code E110**

The code **E110** is displayed when overheating occurs due to a breach in the insulation:

- Remove the heat exchanger.
- Replace the insulation behind the burner bracket.
- Replace the safety thermofuse behind the heat exchanger.

#### 8.1.1 Automatic error code clearing

If the symbol is displayed at the same time as the error code, the error code is automatically cleared when the cause that prompted it stops.

A flow or return temperature in excess of the critical value prompts an error code. The error code is automatically cleared when the temperature drops below the critical value.

#### 8.1.2 Clearing error codes

If the probable cause of an error code is resolved but the error code continues to be displayed, proceed as follows to clear the error code:

1. Press the button.  
The command **Reset? Yes** is displayed on the control panel.
2. Confirm by pressing the button.  
The error code disappears after a few seconds.

## 9 Environmental

### 9.1 Energy savings

---

Tips on saving energy:

- Keep the room in which the boiler is installed well ventilated.
- Do not block ventilation outlets.
- Do not cover the radiators. Do not hang curtains in front of the radiators.
- Install reflective panels behind the radiators to prevent heat losses.
- Insulate the pipes in rooms that are not heated (cellars and lofts).
- Turn off the radiators in rooms not being used.
- Do not run hot (or cold) water pointlessly.
- Install a water-saving shower head to save up to 40% energy.
- Take showers rather than baths. A bath consumes twice as much water and energy.

### 9.2 Room thermostat and settings

---

Various models of room thermostat are available. The type of thermostat used and the parameter selected impact total energy consumption.

- A modulating regulator, which may be combined with thermostatic valves, is eco-friendly in terms of energy and offers an excellent level of comfort. This combination allows you to set the temperature separately for each room. However, do not install thermostatic radiator valves in the room in which the room thermostat is located.
- Complete opening and closing of the thermostatic radiator valves causes undesirable variations in temperature. Therefore, these must be opened/closed progressively.
- Set the room thermostat to a temperature of approximately 20°C to reduce heating costs and energy consumption.
- Lower the thermostat setting to approximately 16°C at night or when you are not at home. This reduces heating costs and energy consumption.
- Lower the thermostat setting well before airing the rooms.
- Set the water temperature to a lower level in summer than in winter (e.g. 60°C and 80°C respectively) when an ON/OFF thermostat is used.
- When clock thermostats and programmable thermostats are to be set, do not forget to take any holidays and days when no one is at home into account.

## 10 Disposal

### 10.1 Disposal and Recycling

Fig.44 Recycling



#### Warning

Removal and disposal of the boiler must be carried out by a qualified installer in accordance with local and national regulations.

If you need to remove the boiler, proceed as follows:

1. Switch off the boiler.
2. Cut the electrical power to the boiler.
3. Close the main gas valve.
4. Close the water mains.
5. Close the gas valve on the boiler.
6. Drain the installation.
7. Remove the air vent hose above the siphon.
8. Remove the siphon.
9. Remove the air/flue gas pipes.
10. Disconnect all pipes on the underside of the boiler.
11. Dismantle the boiler.

## 11 Warranty

### 11.1 General

---

We would like to thank you for buying one of our appliances and for your trust in our product.

In order to ensure continued safe and efficient operation we recommend that the product is regularly inspected and maintained.

Your installer and our service department can assist with this.

### 11.2 Terms of warranty

---

The following provisions do not affect the application, in favour of the buyer, of the legal provisions with regard to hidden defects that are applicable in the buyer's country.

This appliance comes with a warranty that covers all manufacturing faults; the warranty period will commence on the date of purchase stated on the installer's invoice.

The duration of our warranty is shown on the certificate delivered with the appliance.

The warranty period is stated in our price list.

As a manufacturer, we can by no means be held liable if the appliance is used incorrectly, is poorly maintained or not maintained at all, or is not installed correctly (it is your responsibility to ensure that installation is carried out by a qualified installer).

In particular, we cannot be held liable for material damage, intangible losses or physical injury resulting from an installation that does not comply with:

- Legal or regulatory requirements or provisions laid down by the local authorities,
- National or local regulations and special provisions relating to the installation,
- Our manuals and installation instructions, in particular in terms of regular maintenance of the appliances,

Our warranty is limited to the replacement or repair of the parts found to be defective by our technical services team, excluding labour, transfer and transport costs.

Our warranty does not cover replacement or repair costs for parts that may become defective due to normal wear, incorrect usage, the intervention of unqualified third parties, inadequate or insufficient supervision or maintenance, a mains supply that is not appropriate or the use of unsuitable or poor quality fuel.

Smaller parts, such as motors, pumps, electrical valves etc., are guaranteed only if these parts have never been dismantled.

The rights established in European Directive 99/44/EEC, implemented by legal decree No. 24 of 2 February 2002 and published in Official Journal No. 57 of 8 March 2002, remain in force.

## 12 Appendix

### 12.1 Product fiche - Boiler space heaters

Tab.20 Product fiche for boiler space heaters

| Brand name - Product name                      |    | POWER HT+<br>1.50 | POWER HT+<br>1.70 |
|--|----|-------------------|-------------------|
| Seasonal space heating energy efficiency class |    | <b>A</b>          | <b>A</b>          |
| Rated heat output ( <i>Prated or Psup</i> )    | kW | 45                | 65                |
| Seasonal space heating energy efficiency       | %  | 93                | 93                |
| Annual energy consumption                      | GJ | 139               | 201               |
| Sound power level $L_{WA}$ indoors             | dB | 61                | 64                |



**See**

For specific precautions on assembly, installation and maintenance: see the chapter on Safety Instructions.

### 12.2 Product fiche - Temperature Controls

Tab.21 Product fiche for temperature controls

| Baxi - POWER HT +                               |   | HMI text |
|---|---|----------|
| Class   |   | II       |
| Contribution to space heating energy efficiency | % | 2        |

## 12.3 Package fiche

Fig.45 Package fiche for boilers indicating the space heating energy efficiency of the package

|  |  |                                |                          |                          |                          |                          |                          |                          |                          |                          |                          |                          |          |          |          |          |          |          |          |           |            |             |      |      |      |      |      |      |      |      |       |       |
|--|--|--------------------------------|--------------------------|--------------------------|--------------------------|--------------------------|--------------------------|--------------------------|--------------------------|--------------------------|--------------------------|--------------------------|----------|----------|----------|----------|----------|----------|----------|-----------|------------|-------------|------|------|------|------|------|------|------|------|-------|-------|
| <b>Seasonal space heating energy efficiency of boiler</b>  |  | ①                              |                          |                          |                          |                          |                          |                          |                          |                          |                          |                          |          |          |          |          |          |          |          |           |            |             |      |      |      |      |      |      |      |      |       |       |
|  |  | 'I' %                          |                          |                          |                          |                          |                          |                          |                          |                          |                          |                          |          |          |          |          |          |          |          |           |            |             |      |      |      |      |      |      |      |      |       |       |
| <b>Temperature control</b>   | Class I = 1%, Class II = 2%, Class III = 1.5%,<br>Class IV = 2%, Class V = 3%, Class VI = 4%,<br>Class VII = 3.5%, Class VIII = 5% | ②                              |                          |                          |                          |                          |                          |                          |                          |                          |                          |                          |          |          |          |          |          |          |          |           |            |             |      |      |      |      |      |      |      |      |       |       |
| from fiche of temperature control  |  | + [ ] %                        |                          |                          |                          |                          |                          |                          |                          |                          |                          |                          |          |          |          |          |          |          |          |           |            |             |      |      |      |      |      |      |      |      |       |       |
| <b>Supplementary boiler</b>  | Seasonal space heating energy efficiency (in %)  | ③                              |                          |                          |                          |                          |                          |                          |                          |                          |                          |                          |          |          |          |          |          |          |          |           |            |             |      |      |      |      |      |      |      |      |       |       |
| from fiche of boiler   |  | ( [ ] - 'I' ) x 0.1 = ± [ ] %  |                          |                          |                          |                          |                          |                          |                          |                          |                          |                          |          |          |          |          |          |          |          |           |            |             |      |      |      |      |      |      |      |      |       |       |
| <b>Solar contribution</b>  | Tank rating <sup>(1)</sup><br>A* = 0.95, A = 0.91,<br>B = 0.86, C = 0.83,<br>D - G = 0.81  | ④                              |                          |                          |                          |                          |                          |                          |                          |                          |                          |                          |          |          |          |          |          |          |          |           |            |             |      |      |      |      |      |      |      |      |       |       |
| from fiche of solar device   | Collector size (in m <sup>2</sup> )    Tank volume (in m <sup>3</sup> )    Collector efficiency (in %)                             | ④                              |                          |                          |                          |                          |                          |                          |                          |                          |                          |                          |          |          |          |          |          |          |          |           |            |             |      |      |      |      |      |      |      |      |       |       |
|  | ( 'III' x [ ] + 'IV' x [ ] ) x 0.9 x ( [ ] / 100 ) x [ ] = + [ ] %   | + [ ] %                        |                          |                          |                          |                          |                          |                          |                          |                          |                          |                          |          |          |          |          |          |          |          |           |            |             |      |      |      |      |      |      |      |      |       |       |
| (1) If tank rating is above A, use 0.95  |  |                                |                          |                          |                          |                          |                          |                          |                          |                          |                          |                          |          |          |          |          |          |          |          |           |            |             |      |      |      |      |      |      |      |      |       |       |
| <b>Supplementary heat pump</b>   | Seasonal space heating energy efficiency (in %)  | ⑤                              |                          |                          |                          |                          |                          |                          |                          |                          |                          |                          |          |          |          |          |          |          |          |           |            |             |      |      |      |      |      |      |      |      |       |       |
| from fiche of heat pump  |  | ( [ ] - 'I' ) x 'II' = + [ ] % |                          |                          |                          |                          |                          |                          |                          |                          |                          |                          |          |          |          |          |          |          |          |           |            |             |      |      |      |      |      |      |      |      |       |       |
| <b>Solar contribution AND Supplementary heat pump</b>  |  | ⑥                              |                          |                          |                          |                          |                          |                          |                          |                          |                          |                          |          |          |          |          |          |          |          |           |            |             |      |      |      |      |      |      |      |      |       |       |
| select smaller value   | 0.5 x [ ] OR 0.5 x [ ] = - [ ] %   | - [ ] %                        |                          |                          |                          |                          |                          |                          |                          |                          |                          |                          |          |          |          |          |          |          |          |           |            |             |      |      |      |      |      |      |      |      |       |       |
| <b>Seasonal space heating energy efficiency of package</b>   |  | ⑦                              |                          |                          |                          |                          |                          |                          |                          |                          |                          |                          |          |          |          |          |          |          |          |           |            |             |      |      |      |      |      |      |      |      |       |       |
|  |  | [ ] %                          |                          |                          |                          |                          |                          |                          |                          |                          |                          |                          |          |          |          |          |          |          |          |           |            |             |      |      |      |      |      |      |      |      |       |       |
| <b>Seasonal space heating energy efficiency class of package</b>   |  |                                |                          |                          |                          |                          |                          |                          |                          |                          |                          |                          |          |          |          |          |          |          |          |           |            |             |      |      |      |      |      |      |      |      |       |       |
| <table border="1" style="width: 100%; text-align: center;"> <tbody> <tr> <td><input type="checkbox"/></td><td><input type="checkbox"/></td><td><input type="checkbox"/></td><td><input type="checkbox"/></td><td><input type="checkbox"/></td><td><input type="checkbox"/></td><td><input type="checkbox"/></td><td><input type="checkbox"/></td><td><input type="checkbox"/></td><td><input type="checkbox"/></td> </tr> <tr> <td><b>G</b></td><td><b>F</b></td><td><b>E</b></td><td><b>D</b></td><td><b>C</b></td><td><b>B</b></td><td><b>A</b></td><td><b>A*</b></td><td><b>A**</b></td><td><b>A***</b></td> </tr> <tr> <td>&lt;30%</td><td>≥30%</td><td>≥34%</td><td>≥36%</td><td>≥75%</td><td>≥82%</td><td>≥90%</td><td>≥98%</td><td>≥125%</td><td>≥150%</td> </tr> </tbody> </table> |  |                                | <input type="checkbox"/> | <input type="checkbox"/> | <input type="checkbox"/> | <input type="checkbox"/> | <input type="checkbox"/> | <input type="checkbox"/> | <input type="checkbox"/> | <input type="checkbox"/> | <input type="checkbox"/> | <input type="checkbox"/> | <b>G</b> | <b>F</b> | <b>E</b> | <b>D</b> | <b>C</b> | <b>B</b> | <b>A</b> | <b>A*</b> | <b>A**</b> | <b>A***</b> | <30% | ≥30% | ≥34% | ≥36% | ≥75% | ≥82% | ≥90% | ≥98% | ≥125% | ≥150% |
| <input type="checkbox"/>   | <input type="checkbox"/>   | <input type="checkbox"/>       | <input type="checkbox"/> | <input type="checkbox"/> | <input type="checkbox"/> | <input type="checkbox"/> | <input type="checkbox"/> | <input type="checkbox"/> | <input type="checkbox"/> |                          |                          |                          |          |          |          |          |          |          |          |           |            |             |      |      |      |      |      |      |      |      |       |       |
| <b>G</b>   | <b>F</b>   | <b>E</b>                       | <b>D</b>                 | <b>C</b>                 | <b>B</b>                 | <b>A</b>                 | <b>A*</b>                | <b>A**</b>               | <b>A***</b>              |                          |                          |                          |          |          |          |          |          |          |          |           |            |             |      |      |      |      |      |      |      |      |       |       |
| <30%   | ≥30%   | ≥34%                           | ≥36%                     | ≥75%                     | ≥82%                     | ≥90%                     | ≥98%                     | ≥125%                    | ≥150%                    |                          |                          |                          |          |          |          |          |          |          |          |           |            |             |      |      |      |      |      |      |      |      |       |       |
| <b>Boiler and supplementary heat pump installed with low temperature heat emitters at 35°C ?</b>   |  | ⑦                              |                          |                          |                          |                          |                          |                          |                          |                          |                          |                          |          |          |          |          |          |          |          |           |            |             |      |      |      |      |      |      |      |      |       |       |
| from fiche of heat pump  |  | [ ] + ( 50 x 'II' ) = [ ] %    |                          |                          |                          |                          |                          |                          |                          |                          |                          |                          |          |          |          |          |          |          |          |           |            |             |      |      |      |      |      |      |      |      |       |       |

The energy efficiency of the package of products provided for in this fiche may not correspond to its actual energy efficiency once installed in a building, as this efficiency is influenced by further factors such as heat loss in the distribution system and the dimensioning of the products in relation to building size and characteristics.

AD-3000743-01

I The value of the seasonal space heating energy efficiency of the preferential space heater, expressed in %.

- II The factor for weighting the heat output of preferential and supplementary heaters of a package as set out in the following table.
- III The value of the mathematical expression:  $294/(11 \cdot \text{Prated})$ , whereby 'Prated' is related to the preferential space heater.
- IV The value of the mathematical expression  $115/(11 \cdot \text{Prated})$ , whereby 'Prated' is related to the preferential space heater.

Tab.22 Weighting of boilers

| $\text{Psup} / (\text{Prated} + \text{Psup})^{(1)(2)}$ | II, package without hot water storage tank | II, package with hot water storage tank |
|--|--|---|
| 0  | 0  | 0                                       |
| 0.1  | 0.3  | 0.37                                    |
| 0.2  | 0.55                                       | 0.70                                    |
| 0.3  | 0.75                                       | 0.85                                    |
| 0.4  | 0.85                                       | 0.94                                    |
| 0.5  | 0.95                                       | 0.98                                    |
| 0.6  | 0.98                                       | 1.00                                    |
| $\geq 0.7$   | 1.00                                       | 1.00                                    |

(1) The intermediate values are calculated by linear interpolation between the two adjacent values.  
(2) Prated is related to the preferential space heater or combination heater.

Tab.23 Package efficiency

| Baxi - POWER HT +                                   |   | POWER HT+<br>1.50 | POWER HT+<br>1.70 |
|---|---|-------------------|-------------------|
| Seasonal space heating energy efficiency of boiler  | % | 93                | 93                |
| Temperature control                                 | % | 2                 | 2                 |
| Seasonal space heating energy efficiency of package | % | 95                | 95                |







© Copyright

All technical and technological information contained in these technical instructions, as well as any drawings and technical descriptions supplied, remain our property and shall not be multiplied without our prior consent in writing. Subject to alterations.

# BAXI

36061 BASSANO DEL GRAPPA (VI) - ITALY  
Via Trozzetti, 20  
Servizio clienti: Tel +39 0424 517800 - Fax +39 0424 38089  
[www.baxi.it](http://www.baxi.it)



PART OF BDR THERMEA

